

Technical Specs:	
Input Ratings	
Nominal Voltage (VAC)	208VAC, Single Phase, 50/60 Hz
Input Plug / Cord	NEMA L6-20, 10 ft (3m)
Current Rating	20A derated to 16A (NA)
Power Rating (kW)	3.3
Output Ratings	
Nominal Voltage (VAC)	208VAC, 50/60 Hz
Current Rating	16A Total
Outlet Rating	C13: 12A max
Max Current per Breaker	16A Max
Outlet Combination	
Load Segment	CB1: (24) C-13
PDU Total	(24) C13
Branch Circuit Protection	(1) 2-pole 20A UL489 Breaker
Surge Suppression	None

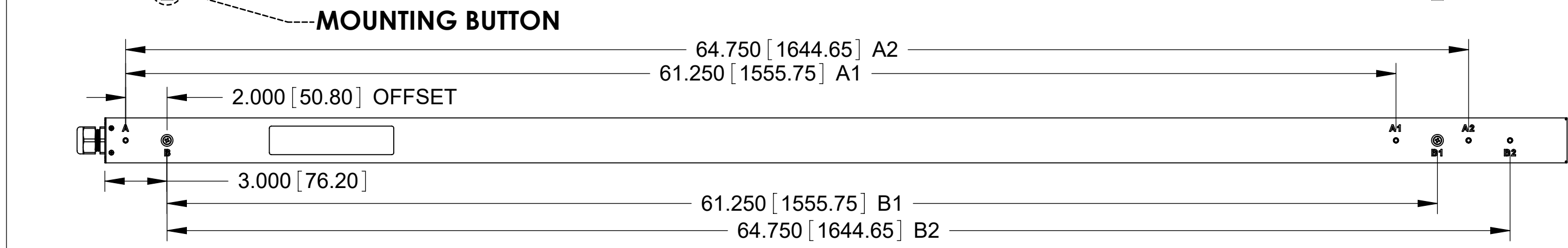

Features:	
Local Display	(1) LCD Display - Branch Monitoring, IP Setup, Alarm Notification
Branch Monitoring	Current, Voltage, Power, PF per Circuit
Monitoring Accuracy	+/- 1% True RMS
Ethernet Port	10/100/1000 Mbps RJ-45
Remote Monitoring	IP v4/v6, SNMP v1/v2/v3, Serial
Remote Control	ON/OFF/CYCLE outlets remotely
IP Consolidation	Link up to 32 PDUs under a single IP address
USB Ports (2)	Update firmware
Control Interface	Built-in Web Browser, HTTP, SNMP, Serial RS-232
Sensor Interface	(2) Temperature and Humidity Sensors
Auxiliary Ports (2)	Front and Rear Electric Door Lock
Cord Retention	Locking Receptacles
Mounting System	Multiple tool-less mounting button locations, A and B (see detail)

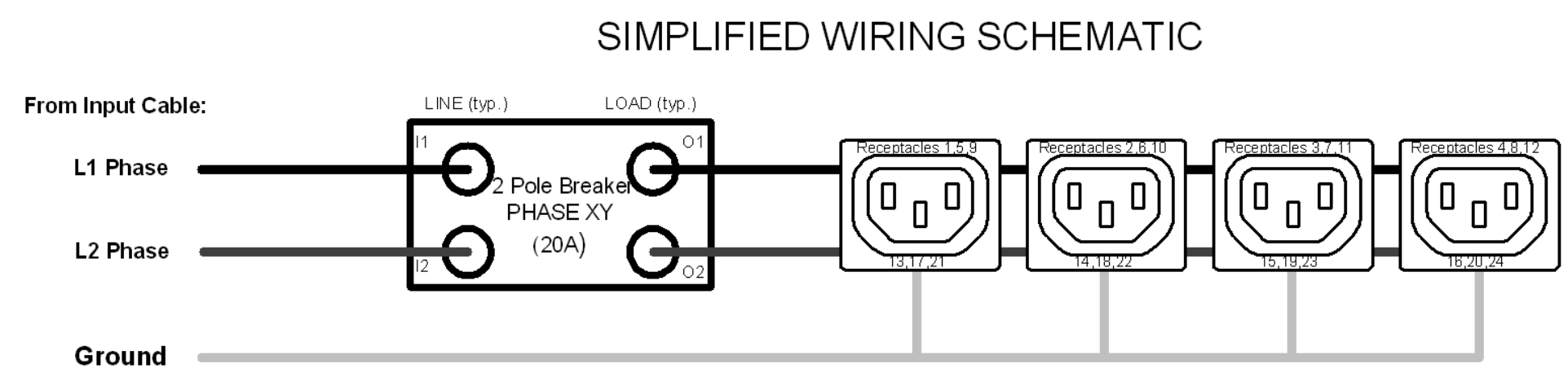
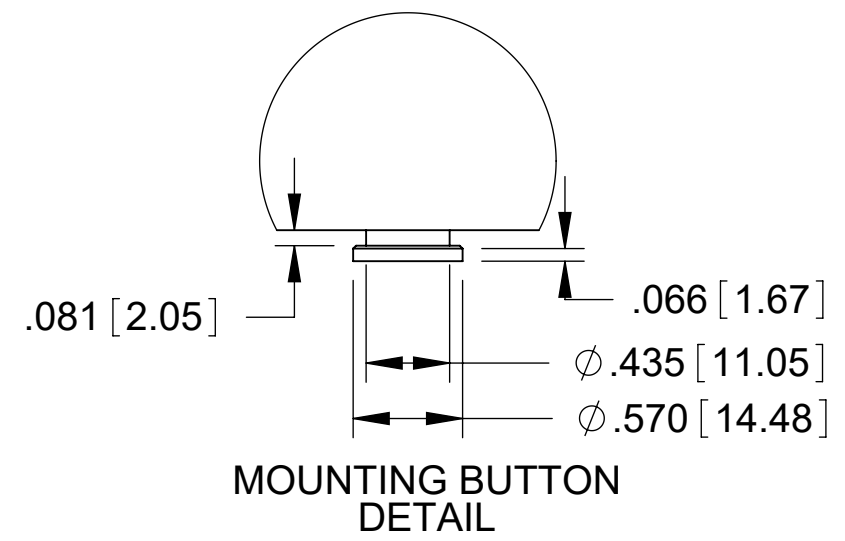
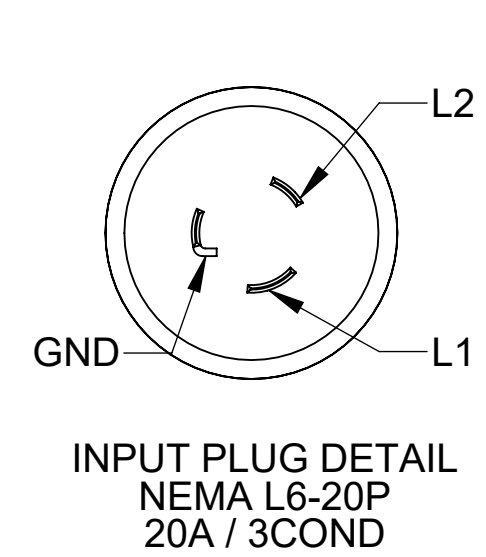
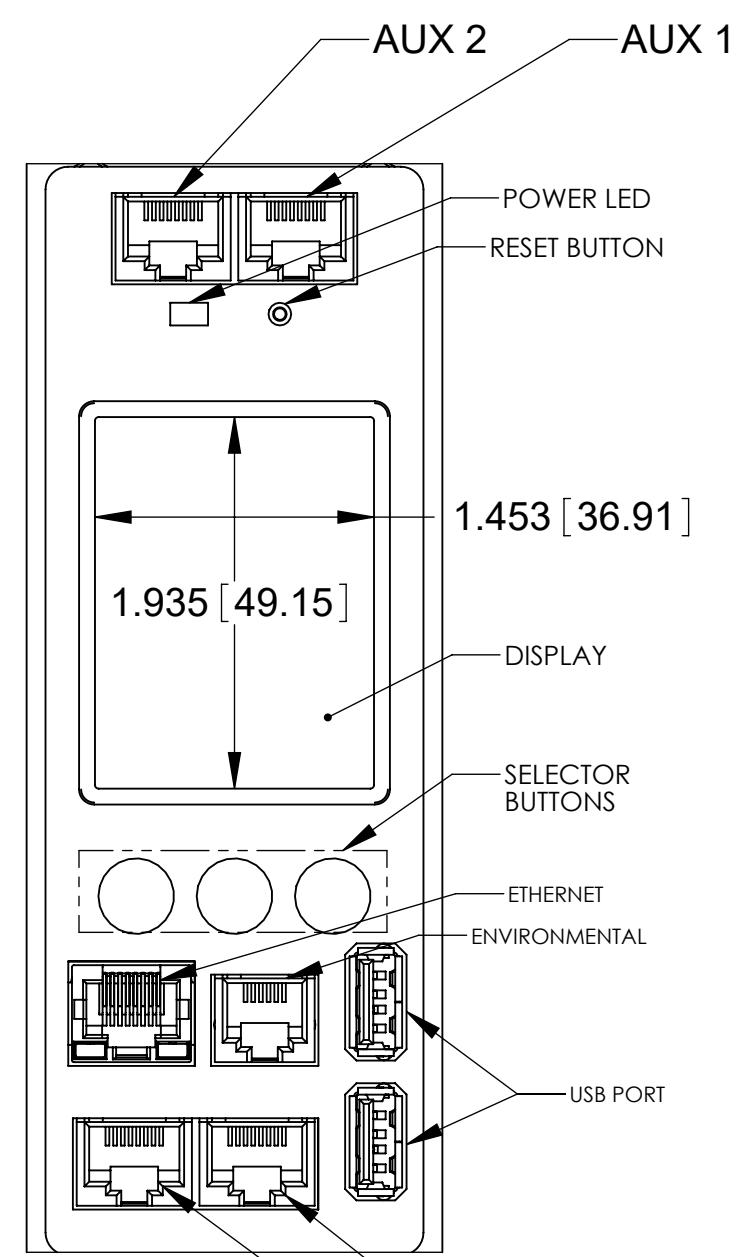

Dimensions & Weights:	
Width (In[mm])	2.2 [55]
Height (In[mm])	70.5 [1791]
Depth (In[mm])	2.2 [55]
Weight (lbs[kg])	18 [8.2]
Regulatory Information:	
UL & cUL Listed, IEC 60950-1, CSA C22.2, CE, NOM, RoHS, FCC Part 15 Class A, EN 55022	
Environmental Conditions:	
Operating Temperature	32 - 149F (0 - 65C)
Operating Rel Humidity	5 - 95%
Operating Elevation	0-10000 ft (0-3000 m)
Storage Temperature	-13 - 149F (-25 - 65C)
Storage Rel Humidity	5 - 95%
Storage Elevation	0-50000ft (0-15000 m)
Hardware Included:	
(2) tool less mounting buttons (1) ground kit cable	
Optional Accessories:	
Temp/Hum Environmental Sensor P/N 35941-132	

Notes:
 1 All Dimension are in inches [millimeters] unless otherwise specified
 2 Installation must conform with all related national and local codes
 3 All Bracket kits are sold separately. Toolless mounting buttons are included for installation in CPI cabinets.
 4 For more information, please contact Tech Support at techsupport@chatsworth.com

©2017 Chatsworth Products, Inc. All rights reserved.
 All products quoted are subject to availability based on manufacturing capacity and shipping dates should be considered estimates only.
 While every effort has been made to ensure the accuracy of all information, CPI does not accept liability for any errors or omissions and reserves the right to change information and descriptions of listed services and products.

CPI CHATSWORTH PRODUCTS, INC.

eConnect Vertical (0U) PDU, Switched, L6-20 Plug, Single Phase, 208V Input, 20A, (24) C13 Outlets, 208V Output, Individual Outlet Control

L5-1E0A1 ISS **1**

SHEET 1 OF 1

THIRD ANGLE