

Installation Instructions

RMR WALL-MOUNT EQUIPMENT RAIL ASSEMBLY

Safety Information



WARNING: Improper use of this product may lead to serious injury. Read and understand all instructions for proper installation and use of this product.

Tools Required

M10 Socket Driver

Included Hardware

- (4) M6 Serrated Flange Hex Nut
- (4) M6 Round Head Bolt
- (4) M6 Star Washer

Assembly Sequence

1. Install Round Head Bolt through Star Washer and slot in mounting flange.
2. Install Rail over Bolt.
3. Attach Nut and tighten. (Torque 168 IN-LB [19.0 N-M])

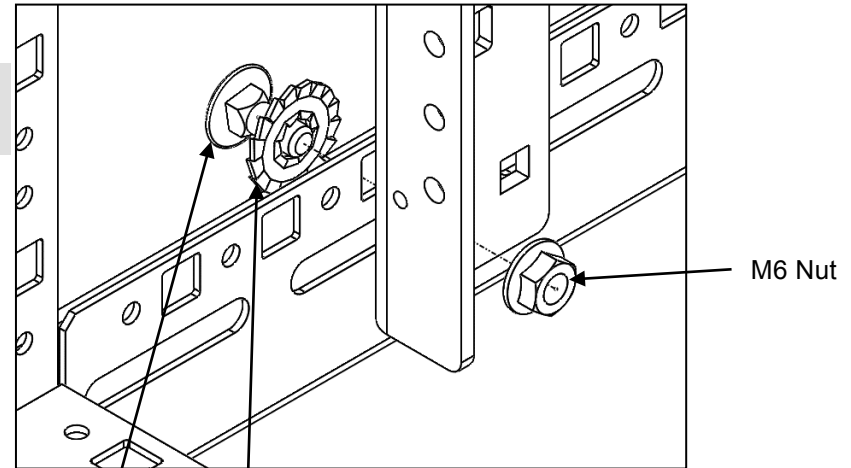

Round Head Bolt
Star Washer

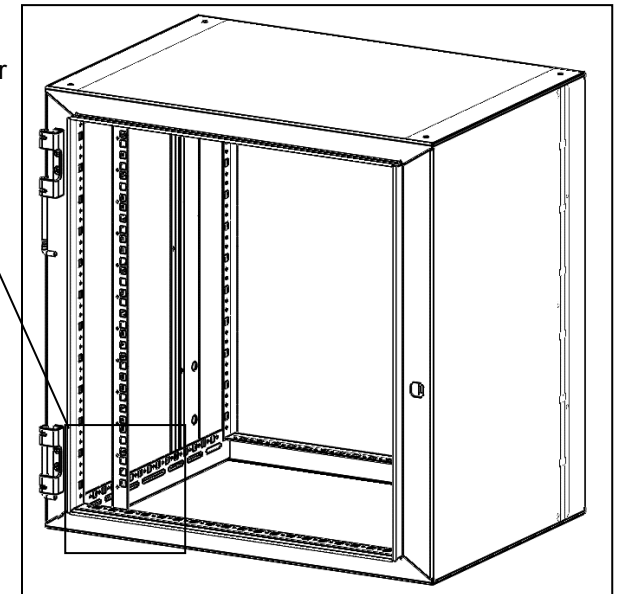

IIS-737067, 09/16/16, Rev. 1, CPI/SJG
800-834-4969 (USA & Canada) • www.chatsworth.com • techsupport@chatsworth.com
For international phone numbers, see our website or contact CPI Tech Support.

This drawing contains proprietary and confidential information and is protected by U.S. and international law. Unauthorized reproduction, disclosure or use of the drawing or the information therein is expressly forbidden except as agreed to in writing by Chatsworth Products, Inc.