

Installation Instructions

RMR 800 MM W CABLE RING MANAGER

Safety Information



WARNING: Improper use of this product may lead to serious injury. Read and understand all instructions for proper installation and use of this product.

Tools Required

10mm socket wrench

Included Hardware

- (2) M6 Drop-in nut
- (2) M6X10 Serrated Flange Hex Head screw

Assembly Sequence

1. Insert M6 drop-in nut into Double-D Cam Hole on top and bottom frame depth members at desired location for cable ring manager. Rotate M6 drop-in nut 90 degrees to engage frame.
2. Install cable ring manager onto frame using M6 Hex Head screws (torque 168 IN-LB [19 N-M]).

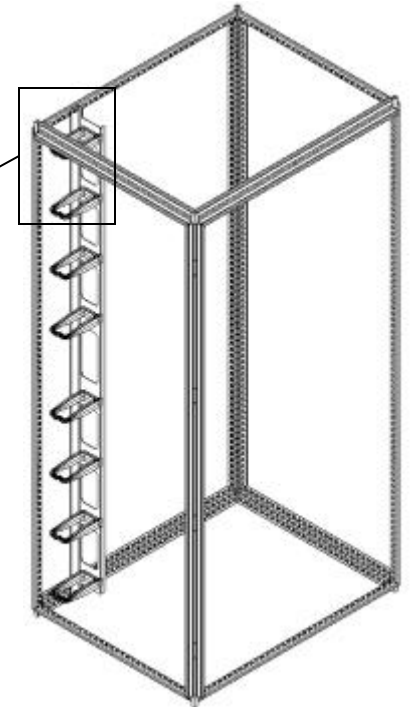
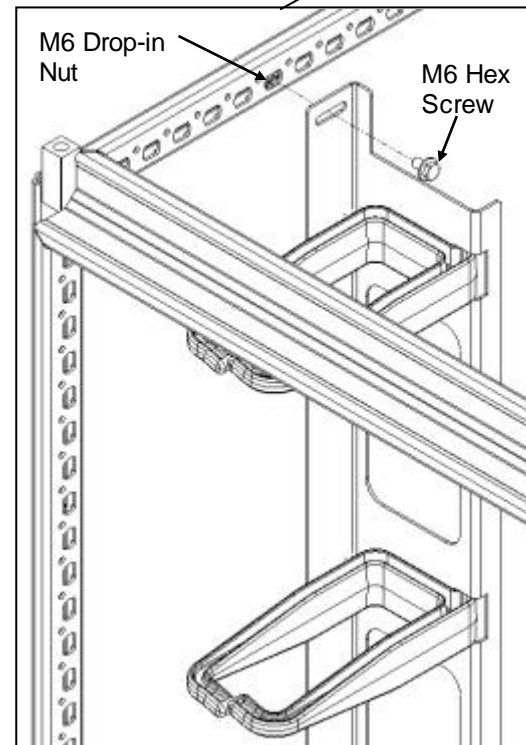
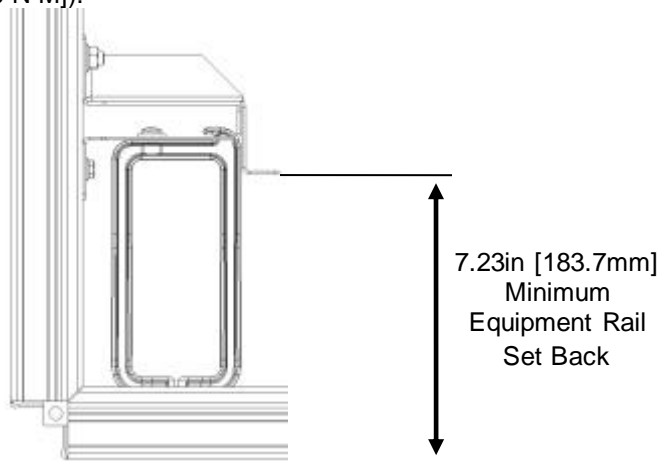

IIS-737802, 07/21/16, Rev. 1, CPI/JAG
800-834-4969 (USA & Canada) • www.chatsworth.com • techsupport@chatsworth.com
For international phone numbers, see our website or contact CPI Tech Support.

This drawing contains proprietary and confidential information and is protected by U.S. and international law. Unauthorized reproduction, disclosure or use of the drawing or the information therein is expressly forbidden except as agreed to in writing by Chatsworth Products, Inc.