



CHATSWORTH
PRODUCTS

Build To Spec (BTS) Kit Hot Aisle Containment (HAC) Solution

The Build To Spec Kit Hot Aisle Containment (HAC) Solution by Chatsworth Products (CPI) is a field-fabricated containment system that includes components to create a duct over a hot aisle as part of a closed hot air return. It is suitable for a mix of cabinets and can be ceiling-supported or cabinet-supported, making it ideal for retrofit applications. The solution accommodates cabinets of varying heights, widths, and depths, providing flexibility for diverse setups.



- 1 Build To Spec Kit (BTS)** – Includes all of the components needed to construct a ceiling-supported or cabinet-supported duct to capture and direct airflow in the contained aisle. This design adapts to a mix of cabinets and allows cabinets to be changed when required. Used as part of a closed return for the air handling system.
- 2 Universal Bulb Seal** – Edge seal used around drop panels to seal gaps above shorter cabinets. Cut excess panels from the BTS to fit the space between the duct and the cabinet. Bulb seal attaches directly to the edge of the panel. Additional panel material is also sold separately.
- 3 Full Height Cabinet Blanking Panel** – Translucent panel and seal used to fill gaps where entire cabinets are omitted from the cabinet row or when adjacent cabinet rows are different lengths. Easy to install or remove in the field. The 48" (1219 mm) wide panels are easy to trim to match the required width.
- 4 Aisle Containment Door Assembly** – Sliding double doors (shown) or single door, both with automatic closing feature and large transparent panel(s). Doors attach to the cabinets at the ends of the aisle to seal the ends of the contained aisle. To simplify installation, a reusable Floor Mounting Template is also available.

- 5 Door Standoff Kit**– Optional kit used when cabinets are placed over a raised floor to offset the door approximately 2.5" (64 mm) away from the side of the cabinets, so that the bottom of the door is not located over the edges of floor tiles.
- 6 Door Top Seal Kit (not shown)** – Optional kit used when doors are shorter than cabinets to seal the gap between the top of the door and the top of the cabinets.
- 7 Door Mounting Bracket Kit (not shown)** – Adjustable height brackets used to attach the Aisle Containment Door Assembly to the tops of cabinets.
- 8 Aisle Containment Cabinet To Floor Seal Kit** – Cabinet-specific trim panels used along the base of cabinets to seal the gap between the floor and the bottom of the cabinet frame.

Containment Accessories
• Floor Mounting Template

Cabinets and Accessories
• Snap-In Filler Panels
• Raised Floor Grommet

Availability: US, Canada, Latin America, Europe, Middle East & Africa

United States & Canada
Simi Valley, CA
800-834-4969
Toronto, Ontario, Canada
+905-850-7770
chatsworth.com
techsupport@chatsworth.com

Latin America
Mexico City, Mexico
+52-55-5203-7525
Toll Free within Mexico
800-201-7592
chatsworth.com.co

Europe
Buckinghamshire
England, UK
+44-1628-524-834

Middle East & Africa
Dubai, UAE
+971-4-2602125
Doha, Qatar
+974-4-267422

Asia Pacific
Jing'an District,
Shanghai, China
+86 21 6880-0266
chatsworth.com.cn

SOLUTION OVERVIEW

- Field-fabricated duct accommodates site differences and existing conditions
- Compatible with a mix of cabinets – different heights, widths and depths in the same row
- Elevated, single-piece duct allows cabinets to be removed, omitted or replaced as required
- Translucent duct panels and transparent door panels allow light to enter the contained aisle
- Doors close automatically to maintain containment and reduce recovery time
- A complete solution maximizes performance with baffles to seal around and within cabinets and the contained aisle
- Durable construction and maintenance-free design provide many years of use

ORDERING INFORMATION

BTS Kit								
Part Number & Finish		Description						Ref. Row Length by Number of Tiles
		Height		Width		Length		
Black	Glacier White	in	mm	in	mm	in	mm	
33000-701	33000-E01	48	1219	96	2438	94	2388	3
33000-702	33000-E02	48	1219	96	2438	188	4775	7
33000-703	33000-E03	48	1219	96	2438	282	7163	11
33000-704	33000-E04	48	1219	96	2438	376	9550	15
33000-705	33000-E05	48	1219	96	2438	470	11 938	19
33000-706	33000-E06	48	1219	96	2438	564	14 326	23
33000-707	33000-E07	48	1219	96	2438	658	16 713	27
33000-708	33000-E08	48	1219	96	2438	752	19 101	31
33000-709	33000-E09	48	1219	96	2438	846	21 488	35
33000-710	33000-E10	48	1219	96	2438	940	23 876	39
33000-711	33000-E11	96	2438	96	2438	94	2388	3
33000-712	33000-E12	96	2438	96	2438	188	4775	7
33000-713	33000-E13	96	2438	96	2438	282	7163	11
33000-714	33000-E14	96	2438	96	2438	376	9550	15
33000-715	33000-E15	96	2438	96	2438	470	11 938	19
33000-716	33000-E16	96	2438	96	2438	564	14 326	23
33000-717	33000-E17	96	2438	96	2438	658	16 713	27
33000-718	33000-E18	96	2438	96	2438	752	19 101	31
33000-719	33000-E19	96	2438	96	2438	846	21 488	35
33000-720	33000-E20	96	2438	96	2438	940	23 876	39
33000-721	33000-E21	48	1219	144	3658	94	2388	3
33000-722	33000-E22	48	1219	144	3658	188	4775	7
33000-723	33000-E23	48	1219	144	3658	282	7163	11
33000-724	33000-E24	48	1219	144	3658	376	9550	15
33000-725	33000-E25	48	1219	144	3658	470	11 938	19
33000-726	33000-E26	48	1219	144	3658	564	14 326	23
33000-727	33000-E27	48	1219	144	3658	658	16 713	27
33000-728	33000-E28	48	1219	144	3658	752	19 101	31
33000-729	33000-E29	48	1219	144	3658	846	21 488	35
33000-730	33000-E30	48	1219	144	3658	940	23 876	39
33000-731	33000-E31	96	2438	144	3658	94	2388	3
33000-732	33000-E32	96	2438	144	3658	188	4775	7
33000-733	33000-E33	96	2438	144	3658	282	7163	11
33000-734	33000-E34	96	2438	144	3658	376	9550	15
33000-735	33000-E35	96	2438	144	3658	470	11 938	19
33000-736	33000-E36	96	2438	144	3658	564	14 326	23
33000-737	33000-E37	96	2438	144	3658	658	16 713	27
33000-738	33000-E38	96	2438	144	3658	752	19 101	31
33000-739	33000-E39	96	2438	144	3658	846	21 488	35
33000-740	33000-E40	96	2438	144	3658	940	23 876	39

Notes:

- The BTS Kit includes the materials needed to create the duct over the cabinets and contained aisle.
- The duct should be slightly larger than the contained aisle; a minimum of 10" (250 mm) wider and 3" (75 mm) longer, so that it overlaps the adjacent cabinets.
- All containment packages come standard with adequate brackets to accommodate a ceiling- or cabinet-supported solution. Order ceiling or cabinet installation hardware separately.
- Doors, full height cabinet blanking panels and additional materials for header/drop panels over cabinets must be ordered separately.



BTS Kit arrives on a pallet and includes eight unique components designed for easy installation and customization on site.



BTS Kit Assembled

ACCESSORIES

Universal Bulb Seal	
Part Number	Description
33003-001	96" L (2438 mm), Pack of 2
33003-002	96" L (2438 mm), Pack of 10

Note: Use as an edge seal around drop panels over cabinets.

Full Height Cabinet Blanking Panel For BTS Kit	
Part Number	Description
33002-X01	94" H x 48" W (2387 mm x 1219 mm), Pack of 2
33002-X02	94" H x 48" W (2387 mm x 1219 mm), Pack of 10

Note: Center panel is translucent, sides and brackets are painted. X=color: 7=Black, E=Glacier White.

Aisle Containment Door Assembly	
Part Number	Description
32770-X01	Double Door, with Painted Door Frames
32770-X02	Double Door, with Anodized Aluminum Door Frames
32780-X02	Single Door, opens to the Right, with Painted Door Frames
32780-X04	Single Door, opens to the Right, with Anodized Aluminum Door Frames
32780-X01	Single Door, opens to the Left, with Painted Door Frames
32780-X03	Single Door, opens to the Left, with Anodized Aluminum Door Frames

Note: X=color: 7=Black, E=Glacier White.

Door Top Seal Kit	
Part Number	Description
For Use With Door Standoff Kit	
32817-X04	Adjusts from 48" W to 59" W (1219 mm to 1500 mm)
32817-X05	Adjusts from 59" W to 70" W (1500 mm to 1775 mm)
32817-X06	Adjusts from 70" W to 81" W (1775 mm to 2050 mm)
For Use Without Door Standoff Kit	
32817-X01	Adjusts from 48" W to 59" W (1219 mm to 1500 mm)
32817-X02	Adjusts from 59" W to 70" W (1500 mm to 1775 mm)
32817-X03	Adjusts from 70" W to 81" W (1775 mm to 2050 mm)

Note: X=color: 7=Black, E=Glacier White.

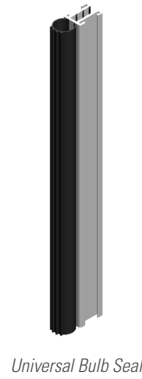

Universal Bulb Seal

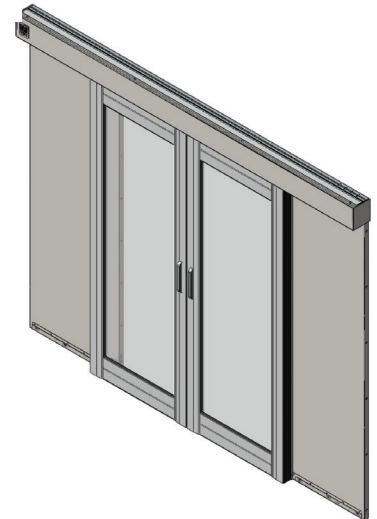

Aisle Containment Door Assembly Double Door

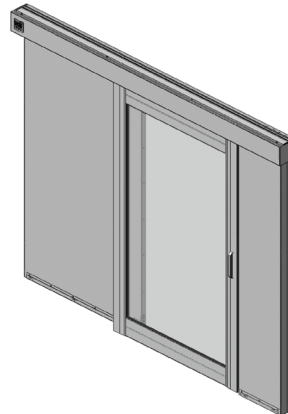

Aisle Containment Door Assembly Single Door, Open to the Left

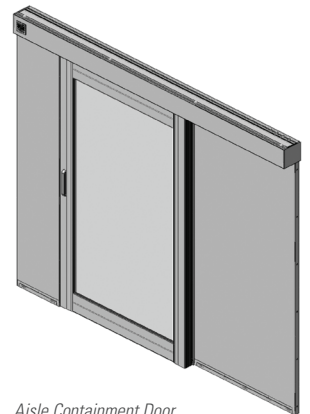

Aisle Containment Door Assembly Single Door, Open to the Right

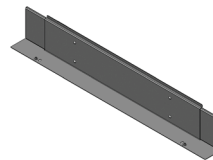

Door Top Seal Kit

ACCESSORIES

Door Mounting Bracket Kit	
Part Number	Description
32805-X00	3" H (75 mm), For 85.3"-91.4" H (2167 mm-2322 mm) Cabinets
32805-X01	5" H (125 mm), For 82.6" -94.2" H (2098 mm -2393 mm) Cabinets
32805-X02	10" H (254 mm), For 77.8"-98.9" H (1976 mm-2512 mm) Cabinets
For Use With Door Standoff Kit	
32805-X03	3" H (75 mm), For 85.3"-91.4" H (2167 mm-2322 mm) Cabinets
32805-X04	5" H (125 mm), For 82.6" -94.2" H (2098 mm -2393 mm) Cabinets
32805-X05	10" H (254 mm), For 77.8"-98.9" H (1976 mm-2512 mm) Cabinets

Note: Two versions, select for use with or without Door Standoff Kit.
X=Color: 7=Black, E=Glacier White.



Cabinet To Floor Seal Kits

Place at the bottom of cabinets to seal the space between the bottom of the cabinet and the floor when leveling feet or casters are in use. Ideal for aisle containment applications.

Aisle Containment Cabinet To Floor Seal Kits Floor Seal Kits for ZetaFrame Cabinet	
Part Number	Description
39996-X00	Front & Rear, for 23.6"W (600 mm) Cabinet
39996-X01	Front & Rear, for 27.6"W (700 mm) Cabinet
39996-X02	Front & Rear, for 29.5"W (750 mm) Cabinet
39996-X03	Front & Rear, for 31.5"W (800 mm) Cabinet
39997-X00	Side Seals, for 31.5"D (800 mm) Cabinet
39997-X08	Side Seals, for 39.4"D (1000 mm) Cabinet
39997-X10	Side Seals, for 41.3"D (1050 mm) Cabinet
39997-X12	Side Seals, for 43.3"D (1100 mm) Cabinet
39997-X16	Side Seals, for 47.2"D (1200 mm) Cabinet

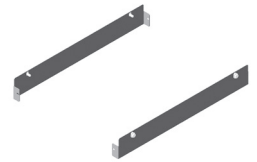
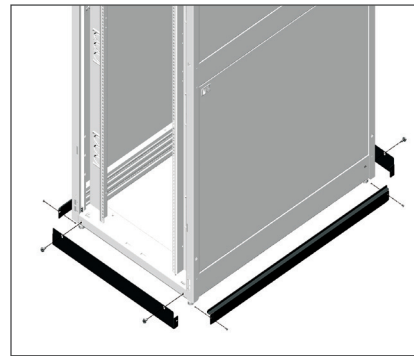

Aisle Containment Cabinet to Floor Front Seal Kit for ZetaFrame Cabinet

Containment Accessories

Use the Floor Mounting Template to locate door mounting holes on the floor.

Floor Mounting Template	
Part Number	Description
32875-701	For Aisle Containment Double-Door, Black
32875-702	For Aisle Containment Single-Door, Black



Thermal Management Accessories

To maximize performance of the containment solution, it is critical to seal any gaps within and between cabinets and any openings in the floor or duct. CPI offers a number of options, including Snap-In Filler Panels and Raised Floor Grommets.

Snap-In Filler Panels	
Part Number	Description
34537-X02	1U x 19" EIA, Pack of 50
34538-X02	2U x 19" EIA, Pack of 50

Note: X=Color: 7=Black, E=Glacier White. Also sold individually.

Raised Floor Grommets	
Part Number	Description
13671-001	Raised Floor Grommets, Each, Black
13671-002	Raised Floor Grommets, Pack of 10, Black



HOW TO GET STARTED

The specific combination of components needed to create a complete BTS Hot Aisle Containment (HAC) Solution depends on a number of factors, including room layout, ceiling height and what types of cabinets models are selected.

To ensure you have a complete solution that addresses site- and cabinet-specific requirements, please contact CPI Technical Support for assistance developing a Bill of Materials (BOM).

Based on your input, CPI Technical Support will propose a complete solution with a drawing and detailed BOM. They will take the time to explain each selection, so you have a complete understanding of how CPI solutions will provide desired results.

Example Bill Of Materials (BOM) / BTS Hot Aisle Containment (HAC) Solution			
Item	Part Number	Description	Qty
1	33000-713	BTS Kit, 96"H x 96"W x 282"L (2438 mm x 2438 mm x 7163 mm), Black	1
2	33003-002	Universal Bulb Seal, 96"L (2438 mm), Pack of 10	1
3	33002-701	Full Height Cabinet Blanking Panel, 94"H x 48"W (2387 mm to 1219 mm), Pack of 2	1
4	32770-702	Aisle Containment Double Door Assembly, Black with Anodized Door Frames	2
5	32870-701	Door Standoff Kit, for Double Door Assembly	2
6	32817-706	Door Top Seal Kit, For Use With Door Standoff Kit, 70"W to 81"W (1775 mm to 2050 mm)	2
7	32805-703	Door Mounting Bracket Kit, 3"H (75 mm)	2
Recommended Accessories			
	32875-701	Installation Template, Aisle Containment Double Door Assembly	1
	34537-702	Snap-In Filler Panel, 1U x 19"EIA, Black, Pack of 50	2
	34538-702	Snap-In Filler Panel, 2U x 19"EIA, Black, Pack of 50	2
	13671-002	Raised Floor Grommet, 10 Pack, Black	2



Required Measurements:

1. Floor to Ceiling Height 144" (3658 mm)
2. Maximum Cabinet Height 89.9" (2282 mm)
3. Maximum Cabinet Aisle Width 66" (1676 mm)
4. Cabinet Row Length 210" (5334 mm)

Required Calculations:

5. Containment Duct Height 54.1" (1476 mm)
Floor to Ceiling Height minus Maximum Cabinet Height.
6. Containment Aisle Width 76" (1930 mm)
Maximum Cabinet Aisle Width plus 10" (250 mm).
7. Containment Row Length 213" (5410 mm)
Cabinet Row Length plus 3" (75 mm).

Notes: This example BOM is based on a solution for the mix of 16 cabinets shown in the image to the right. Example calculations for determining the correct BTS Kit part number are listed below the image. Recommended Accessories include Thermal Management Accessories to seal the gaps within and around cabinets. Contact CPI Technical Support (techsupport@chatsworth.com) to develop a BOM for your site.

All suggestions and performance statements are based on using an overall approach to airflow containment through the use of CPI Products and solutions. For more information about CPI's Aisle Containment Services or products, call 800-834-4969, email techsupport@chatsworth.com or contact your Regional Sales Manager.

chatsworth.com
techsupport@chatsworth.com
 800-834-4969



While every effort has been made to ensure the accuracy of all information, CPI does not accept liability for any errors or omissions and reserves the right to change information and descriptions of listed services and products.

©2024 Chatsworth Products, Inc. All rights reserved. Chatsworth Products, Click-Nut, CPI, CPI Passive Cooling, CUBE-iT, Secure Array, Elevate, eConnect, Evolution, GlobalFrame, MegaFrame, QuadraRack, RMR, Saf-T-Grip, SeismicFrame, SlimFrame, TeraFrame, Motive, EuroFrame, Velocity Wi-Fi-Tile, and ZetaFrame are federally registered trademarks of Chatsworth Products. H-Plane, Hi-Bar, In-Plane, M-Frame, NetPoint, Oberon, Simply Efficient, Skybar, and are trademarks of Chatsworth Products. All other trademarks belong to their respective companies. 04/24 MKT-CPI-805